

High IP3 Frequency Mixer

MCA-19FH+ MCA-19FH

Level 17 (LO Power+17 dBm) 1850 to 1910 MHz



CASE STYLE: DZ883
PRICE: \$11.95 ea. QTY.(1-9)

**+ RoHS compliant in accordance
with EU Directive (2002/95/EC)**

*The +Suffix identifies RoHS Compliance. See our web site
for RoHS Compliance methodologies and qualifications.*

Maximum Ratings

Operating Temperature	-55°C to 100°C
Storage Temperature	-55°C to 100°C
LO & RF Power	20 dBm
Permanent damage may occur if any of these limits are exceeded.	

Pin Connections

LO	10
RF	5
IF	3
GROUND	1,2,4,6,7,8,9

Outline Drawing

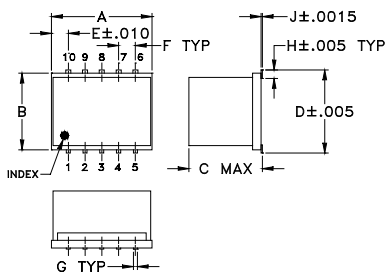

PCB Land Pattern

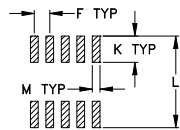

Suggested L layout,
Tolerance to be within ±0.02

Outline Dimensions (inch/mm)

A	B	C	D	E	F	G
.30	.250	.190	.266	.050	.050	.012
7.62	6.35	4.83	6.76	1.27	1.27	0.30
H	J	K	L	M		wt
.029	.004	.085	.296	.030		grams
0.74	0.10	2.16	7.52	0.76		0.5

Demo Board MCL P/N: TB-144 Suggested PCB Layout (PL-045)

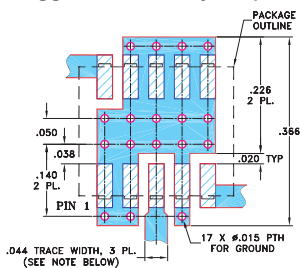

NOTES: 1. TRACE WIDTH IS SHOWN FOR ROGERS RO4350B WITH DIELECTRIC THICKNESS .020" ± .0015"; COPPER: 1/2 OZ. EACH SIDE. FOR OTHER MATERIALS TRACE WIDTH MAY NEED TO BE MODIFIED.
2. BOTTOM SIDE OF THE PCB IS CONTINUOUS GROUND PLANE.

- DENOTES PCB COPPER LAYOUT WITH SMOBC (SOLDER MASK OVER BARE COPPER)
- DENOTES COPPER LAND PATTERN FREE OF SOLDER MASK

Features

- excellent IP3, 35 dBm typ.
- excellent L-R isolation, 40 dB typ.
- excellent 1 dB compression, RF>LO power
- industry standard foot print
- LTCC design for excellent temperature stability, performance repeatability and small size
- aqueous washable
- double balanced mixer
- low price
- protected by US Patent 6,959,180

Applications

- GSM 1800
- DECT

Electrical Specifications (T_{AMB} = -55°C to 100°C)

FREQUENCY (MHz)			IP3 (dBm)	RF in at 1 dB compr. (dBm)	CONVERSION LOSS (dB)		LO-RF ISOLATION (dB)		LO-IF ISOLATION (dB)	
RF	LO	IF	Typ.	Min.	Typ.	Max.	Typ.	Min.	Typ.	Min.
1850-1910	1760-1820	70-130	35	17	6.9	8.5	40	22	39	20

Typical Performance Data

Frequency (MHz)		Conversion Loss (dB)	Isolation L-R (dB)	Isolation L-I (dB)	VSWR RF Port (:1)	VSWR LO Port (:1)	IP3 (dBm)
RF	LO	LO +17dBm	LO +17dBm	LO +17dBm	LO +17dBm	LO +17dBm	LO +17dBm
1850.00	1760.00	6.97	42.92	49.99	1.97	2.39	37.53
1865.00	1775.00	6.97	41.92	45.39	2.00	2.08	36.85
1880.00	1790.00	6.93	40.95	41.21	1.97	1.96	36.93
1895.00	1805.00	6.88	40.70	38.54	1.92	2.01	36.79
1910.00	1820.00	6.82	40.68	36.69	1.90	2.25	37.12

Electrical Schematic

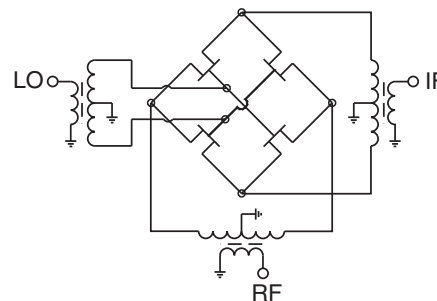

Mini-Circuits
ISO 9001 ISO 14001 AS 9100 CERTIFIED

For detailed performance specs
& shopping online see web site

P.O. Box 350166, Brooklyn, New York 11235-0003 (718) 934-4500 Fax (718) 332-4661 The Design Engineers Search Engine Provides ACTUAL Data Instantly at minicircuits.com

IF/RF MICROWAVE COMPONENTS

Notes: 1. Performance and quality attributes and conditions not expressly stated in this specification sheet are intended to be excluded and do not form a part of this specification sheet. 2. Electrical specifications and performance data contained herein are based on Mini-Circuit's applicable established test performance criteria and measurement instructions. 3. The parts covered by this specification sheet are subject to Mini-Circuit's standard limited warranty and terms and conditions (collectively, "Standard Terms"); Purchasers of this part are entitled to the rights and benefits contained therein. For a full statement of the Standard Terms and the exclusive rights and remedies thereunder, please visit Mini-Circuit's website at www.minicircuits.com/MCLStore/terms.jsp.

REV. D
M102713
ED-9488A/2
MCA-19FH
DJ/TD/CP
071206
Page 1 of 2

Performance Charts

MCA-19FH+ MCA-19FH

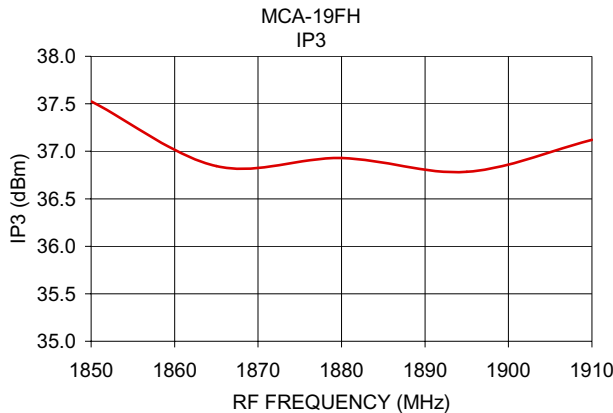
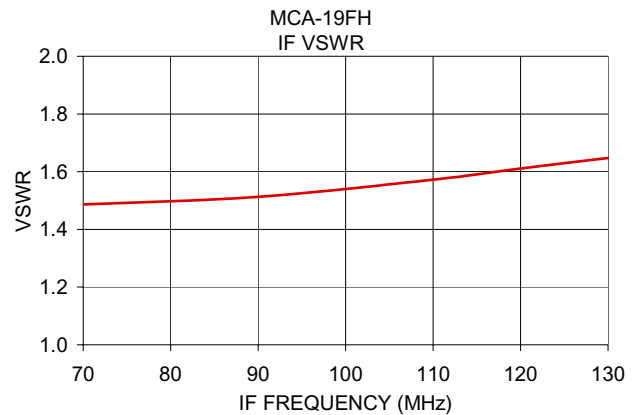
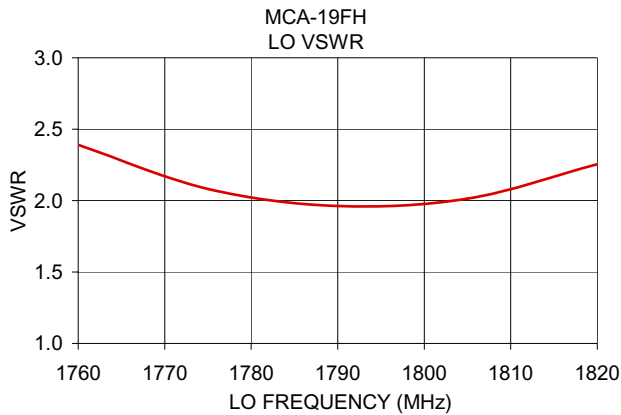
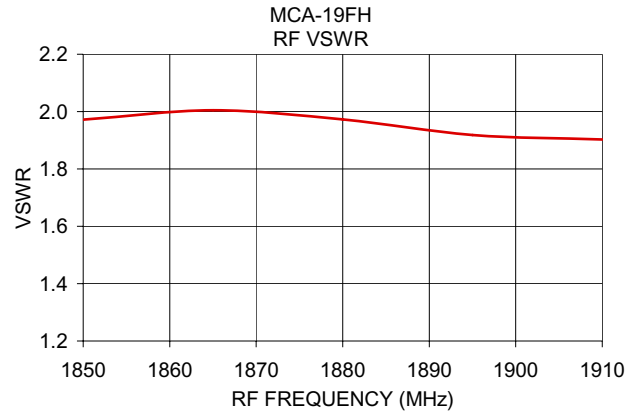
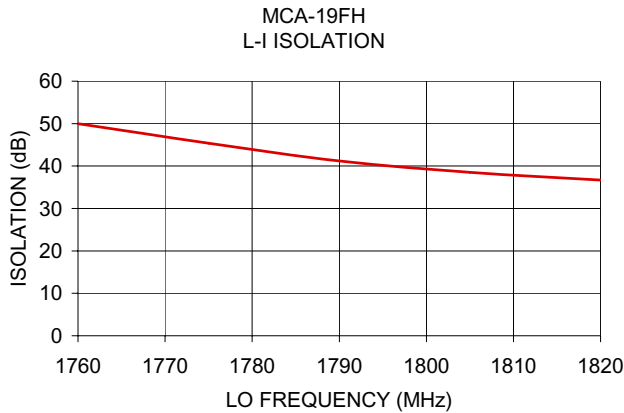
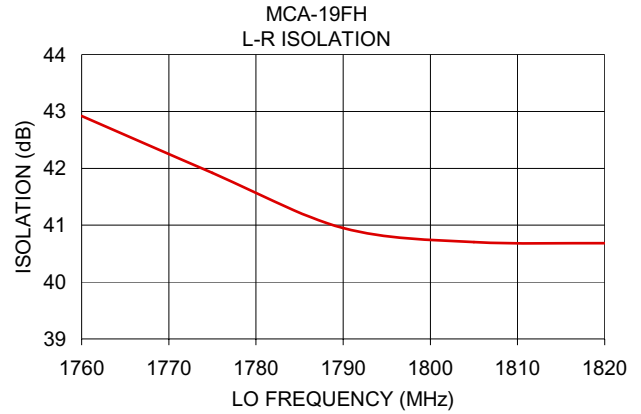
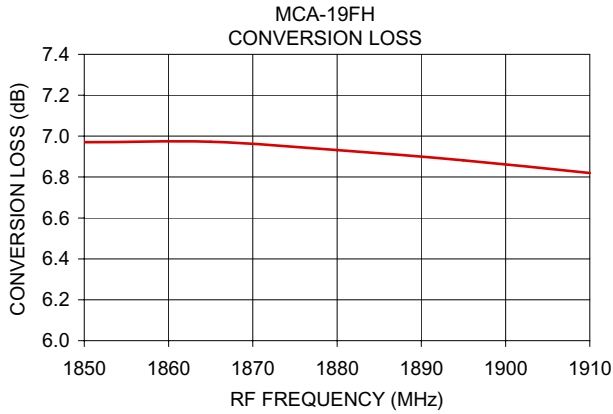

For detailed performance specs & shopping online see web site

P.O. Box 350166, Brooklyn, New York 11235-0003 (718) 934-4500 Fax (718) 332-4661 The Design Engineers Search Engine Provides ACTUAL Data Instantly at minicircuits.com

IF/RF MICROWAVE COMPONENTS

Notes: 1. Performance and quality attributes and conditions not expressly stated in this specification sheet are intended to be excluded and do not form a part of this specification sheet. 2. Electrical specifications and performance data contained herein are based on Mini-Circuit's applicable established test performance criteria and measurement instructions. 3. The parts covered by this specification sheet are subject to Mini-Circuits standard limited warranty and terms and conditions (collectively, "Standard Terms"); Purchasers of this part are entitled to the rights and benefits contained therein. For a full statement of the Standard Terms and the exclusive rights and remedies thereunder, please visit Mini-Circuits' website at www.minicircuits.com/MCLStore/terms.jsp.